

55085 Mini Vane Hall Effect Sensor Features and Benefits

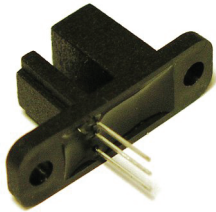

Features

- Sensor and magnet contained in a single housing
- Sensor operates when ferrous vane passes through slot
- 3 pin leadout integral to sensor
- Vibration 50g max. @ 50-2,000Hz
- Shock 150g max. @ 11ms 1/2 Sine
- EMC to DIN 40839 (Consult Hamlin)
- Reverse/Over Voltage Protection
- Built in temperature compensation

Benefits

- High switching speed up to 10kHz
- Long life; up to 20 billion operations
- Unaffected by harsh environments
- Operates in static or dynamic magnetic field
- Small package size
- Simple installation and adjustment

Applications

- Position and limit sensing
- Shaft rotation sensing
- Security systems
- Linear actuators
- Angle sensing
- Magnetic encoders

DIMENSIONS (in) mm

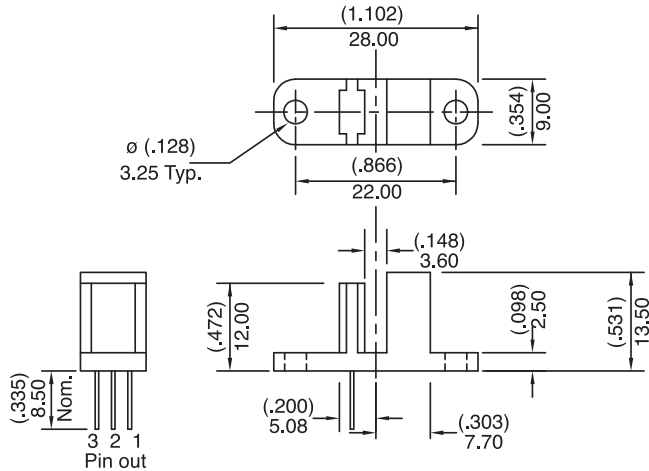

BLOCK DIAGRAM

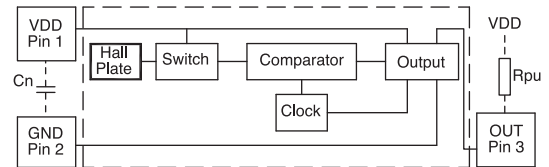

Notes

- 1) Add capacitor Cn as shown, close to the sensor, for transient suppression if required
- 2) Add resistor Rpu as shown for sinking output

CUSTOMER OPTIONS - SPECIFICATION

Hall Type			Digital Switch
			3 Wire (Voltage Output)
Supply Voltage (Note 1)	Absolute Ratings	Vdc	-15 to +28
	Recommended	Vdc	+3.8 to +24
	Overvoltage Protection	Vdc-max	32
Output High Voltage		Vdc	sinking output
Output Low Voltage		Vdc-max	0.4 @ 20mA
Output Current (continuously on)		mA-max	20
Switching Speed		kHz-max	10
Temperature	Operating	°C	-40 to +100
	Storage	°C	-65 to +105

Note 1 - As long as Tj (Junction Temperature) max. is not exceeded

CUSTOMER OPTIONS - ACTIVATION (in) mm

Activate Distance is approximate using a (.100) 2.54 thick ferrous vane as illustrated

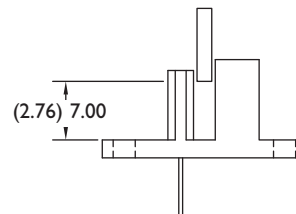

ORDERING INFORMATION

55085 - 3M - 00 - 0

Series 55085

Hamlin USA Tel: +1 920 648 3000 • Fax: +1 920 648 3001 • Email: sales.us@hamlin.com
Hamlin UK Tel: +44 (0)1379 649700 • Fax: +44 (0)1379 649702 • Email: sales.uk@hamlin.com
Hamlin Germany Tel: +49 (0) 6181 953660 • Fax: +49 (0) 6181 953666 • Email: sales.de@hamlin.com
Hamlectrol France Tel: +33 (0) 1 4687 0202 • Fax: +33 (0) 1 4686 6786 • Email: sales.fr@hamlin.com

Issue No: 3 Date: 24/03/03 DCR: B0063

DETAILS PROVIDED ON THIS DATA SHEET ARE PROVIDED FOR INFORMATION PURPOSES ONLY AND SHOULD NOT BE RELIED UPON AS BEING ACCURATE FOR ANY PARTICULAR PURPOSE. Product performance may be affected by the application to which the product is put. Upon request, HAMLIN will assist purchasers by providing information specific to any particular application. HAMLIN disclaims any and all liability whatsoever for any purchaser's reliance upon the information contained on this data sheet without further consultation with authorised representatives of HAMLIN.